

Specific Construction Water Management Plan

Northern Construction Yard

Reference: North Z2 at CH 400 – 600. MAIN YARD_RPT 1110

MMA-DES-ESC-E1-RPT-1110



Revision schedule		
Rev. Number	Date	Description
0.	25 May 2018	Updated for Council
1.	17 July 2018	Updated for Council Hearing

Disclaimer

This report has been prepared by the Mt Messenger Alliance for the benefit of the NZ Transport Agency. No liability is accepted by the Alliance Partners or any employee of or sub-consultant to the Alliance Partners companies with respect to its use by any other person. This disclaimer shall apply notwithstanding that the report may be made available to other persons for an application for permission or approval or to fulfil a legal requirement.

Contents

1	SCWMP Overview	3
1.1	Purpose	3
1.2	Scope	3
1.3	Description	3
1.4	Soil Conditions	4
1.5	Monitoring	5
2	Construction Method and Erosion and Sediment Control Measures	6
2.1	Overview	6
2.3	Stabilisation	8
2.5	Works within 20 Year ARI Flood Plain	9
2.6	Risk Analysis and Contingency Measures	10
2.7	Yard Operations	11
	Appendix A: Drawings and calculations	13
	Appendix B: Chemical Treatment Bench Tests and Design	14

1 SCWMP Overview

1.1 Purpose

This Specific Construction Water Management Plan (SCWMP) has been prepared in accordance with the guidance in the Construction Water Management Plan (CWMP) to meet resource consent conditions and the SCWMP template appended to the CWMP.

This SCWMP is considered a field document, and is developed in consultation with suitably qualified staff (e.g. construction supervisors and engineers) to guide construction works (refer Section 2).

This SCWMP may be updated over time based on feedback from Taranaki Regional Council (TRC) compliance staff and/or in response to lessons learned as works proceed and/or as part of the CWMP review process.

1.2 Scope

This SCWMP covers the activity of establishing the Northern Construction Yard. The location of this activity is shown on Drawing MMA-DES-ESC-E1-DRG-1111 (attached in Appendix A).

This SCWMP addresses the Establishment works of earthworks to construct:

- Flood protection bunds;
- The main access road; and
- The yard platform, including progressively installing required services.

These works, and associated construction details are shown on Drawings MMA-DES-ESC-E1-DRG-1112 to 1115 (attached in Appendix A).

The construction sequence makes reference to a staged approach for developing the construction yard (i.e Stage 4 carried out separately to Stages 1-3) over a two month period. This is to allow for delayed permission to remove the existing residential dwelling.

This SCWMP also makes reference to the relevant management plans to minimise and manage dust and sediment during operation of the yard.

1.3 Description

The works are located within the Tongaporutu Catchment.

The potential maximum open earthwork area associated with this SCWMP is 1 ha.

All areas within Appendix A of this SCWMP will be progressively stabilised, and it is unlikely that this whole area will be open at once.

Table 1.1 – Activity and duration

Works type	✓	Description	Duration	Area (ha)	Earthworks volume (m ³)
Establishment works	✓	Earthworks required to construct access, flood protection bunds and yard platform.	Initial construction: Up to 2 months	1.0 but with progressive stabilisation	12,500
Stream works	×	NA			
Main earthworks	×	NA			

1.4 Site Conditions

Existing site conditions at the Northern Construction Yard comprise:

- A residential dwelling, farm sheds, farming material and equipment;
- Soil materials eroded from the surrounding hillsides which have been re-deposited as soft, compressible soils (predominately silt); and
- A high groundwater table throughout the year.

Some settlement of the existing soft ground beneath the yard and flood protection bunds is considered likely.

Prior to earthworks commencing, the site will be cleared of farming material and equipment and existing buildings removed. Waste and demolition material will be disposed to an approved facility if required.

Excavation of soil beneath the observed groundwater table will be avoided where possible. Topsoil will be stripped to form temporary bunds during the construction phase. Surplus topsoil and any undercut material (if any) will be disposed at established disposal sites (e.g. Fill disposal 4).

Soil material for establishing the Northern Construction Yard will initially be **imported from off-site**. Concurrent establishment works to establish a cut area within the project alignment are proposed, so that site won soil material may be used for completing the yard. Soil sourced from within the project alignment would comprise soft siltstone and sandstone rock of the Mount Messenger Formation. Hard fill for stabilisation will be imported from off-site.

Chemical Flocculation will be required for Establishment works. Flocculation application rates will be monitored to ensure dosing continues to be effective with the changing geology.

It is not expected earthworks will encounter soil conditions, such as acid based soils, that would compromise the effectiveness of the erosion and sediment control measures or

methodology proposed. If any unexpected geological conditions are encountered, discussions will be held with the TRC monitoring officer to determine appropriate contingency measures.

1.5 Monitoring



This SCWMP will be monitored in accordance with the Monitoring Programme as per resource consent conditions and the CWMP. This will follow the procedures for adapting the controls in response to the monitoring outcomes.

An important focus of site monitoring will be to ensure that when large or high intensity rainfall events are forecasted, appropriate monitoring and or maintenance is implemented in response. This monitoring will include a 'feedback loop' to ensure that all personnel are aware of any changing requirements and or any improvements to management practices.

2 Construction Method and Erosion and Sediment Control Measures

2.1 Overview

This SCWMP has been prepared and reviewed by the following suitably qualified persons:

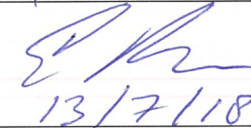
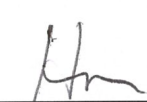
SCWMP prepared by:		Sharon Parackal E&SC Engineer
Construction method(s) reviewed by:	 13/7/18	Stu Haynes Construction Manager
SCWMP reviewed by:	 13/7/18	Ed Breese Environmental Manager
Approved for Release:		Hugh Milliken Alliance Manager

All erosion and sediment control measures have been designed by a suitability qualified staff who meet the following requirements:

Plan Preparation Requirements (as per SCWMP template)	✓
Is familiar with the requirements of the Transport Agency Guidelines, conditions of consent (under draft), the CWMP and any supporting plans (e.g. Chemical Treatment Plans).	✓
Is familiar with expected site conditions and proposed construction methodologies relevant to this SCWMP.	✓
Is familiar with topographical lay of the surrounding land relevant to this SCWMP.	✓
Has completed a site visit relevant to this SCWMP.	✓

2.2 Specific control measures

The construction of the yard will be staged so that the dirty water catchment does not exceed 0.3 ha (DEB design catchment). Prior to earthworks commencing:

- Construct the stabilised site entrance/access point (refer separate SCWMP);
- Existing farm sheds, material and equipment will be removed;
- Any existing farm drains will be blocked; and
- Clean water drains will be installed or increased in capacity to divert the upslope catchment for the design event.

During earthworks, short term ponding of water from stabilised stages will be enabled by installing a geotextile lined bund (min. 0.5 m high) between the stages.

Note: Some ground settlement is expected. Construction supervisor to monitor the need for releveling/shaping of the yard/drains to fall towards the DEB intake point.

Table 2.1 summarises the sequence of works and the specific application of erosion and sediment control measures from the CWMP. Refer to Appendix A for further details: Drawings MMA-ESC-E1-DRG-1112 to 1114; Design calculations for DEB-YD; and the clean water diversions.

Table 2.1 – Establishment work sequence and erosion and sediment control (ESC) measures

Work Sequence		ESC measures	Comments
1A	Set out stream buffer zone. Set out toe of flood protection bunds so it doesn't encroach into the buffer zone. Install silt fence at toe.	Silt fences (Detail 1). Clean water drains type A (Detail 3). DEB-YD (Detail 4).	DEB installed as per Detail 4. DEB outer batter face stabilised with pinned geotextile. Install flocculation system at DEB.
1B	Blocking off existing farm drains and culverts. Install clean water drains to divert the upslope catchment.		
1C	Construct DEB-YD. DEB-YD is sized for a 0.3 ha earthwork catchment.		
2.	Staged earthworks to construct and stabilise bunds, access road and yard. Stripped topsoil will be pushed into a temporary bund.	Staging as per Drawing MMA-ESC-E1-DRG-1114. Geotextile lined bund to separate stabilised and earthworking stages. Bund to enable temporary ponding on the stabilised surface.	Flood protection bund constructed and stabilised as per Detail 2. No more than 50 m length of unlined batter face at the end of each working day.

Work Sequence		ESC measures	Comments
		Silt fence (Detail 1). DEB-YD (Detail 4). Silt fence (Detail 1).	Dirty water cut-off drain reinstated at the end of each day, and prior to forecasted rain. Yard progressively stabilised with 150 mm hardfill (e.g. AP65).
3.	Remove existing dwelling once permission is obtained. Realign cleanwater drain. Complete final stage of earthworks to extend the yard. Stripped topsoil will be pushed into a temporary bund. Localised trenching to install services.	Staging as per Drawing MMA-ESC-E1-DRG-1114. Geotextile lined bund to separate stabilised and earthworking stages. Bund to enable temporary ponding on the stabilised surface. Clean water drains type B (Detail 3). DEB-YD (Detail 4).	Shaping of earthworks to fall towards DEB intake. Yard progressively stabilised with 150 mm hardfill (e.g. AP65). Trenches to install services will be progressively backfilled as services are installed.

Chemical treatment will be required for the Establishment works (Steps 1–3) outlined in Table 2.1 above.

The flocculation design details for these earthworks and supporting bench testing are attached in Appendix B. Bench testing has been carried out on expected site-won structural fill material. If imported material is required to construct the yard pad, bench testing on this material will be necessary prior to construction.

It is possible that further bench testing will be required as earthworks progress with this informing ongoing flocculation management on site.

Note: Once the yard is stabilised with hardfill, DEB-YD will be monitored and if results indicate sediment laden run-off is being generated from the site, the pond will be enlarged for a 0.85 ha catchment (approx. 26 m long x 9 m wide). During this time, chemical treatment may cease if further bench testing demonstrates flocculation is not required.

2.3 Stabilisation

The CWMP sets out the definition of **Stabilised Area** and **Actively Worked**. Areas not subject to works for more than a 14-day period will be identified and stabilised as works proceed (referred as “Stabilisation Trigger”).

As per SCWMP template	
Stabilisation Trigger:	14 days not Actively Worked
Is the Stabilisation Trigger likely to occur	Yes or <input checked="" type="radio"/> No
Stabilisation techniques	Flood protection bunds: Pinned geotextile on the inside and outside fill batters.
	Yard platform: 150 mm hard fill
	Clean water diversions: Pinned geotextile on the base and inside batter face.
	Temporary bunds to separate clean and dirty: Pinned geotextile on the outside face.
Frequency of check on Activity Worked area	Weekly checks by the Construction Supervisor. Records of these checks will be maintained by the ESC Supervisor.

2.4 Works within 20 Year ARI Flood Plain

The Northern Construction Yard will be operated within flood plain of the Mangapepeke Stream.

The location of this yard is considered the only viable option for this SCWMP. Flood protection bunds will be constructed around the perimeter of this yard to provide protection from flood flows.

Based on the predicted flood depth, a standard freeboard level of 0.6 m above the primary spillway is sufficient to prevent flood waters from overtopping the yard in a 1% AEP event. Note: the allowance for expected settlement will be additional to this.

The flood protection bunds will be constructed and stabilised to meet the required geotechnical specification for structural fill.

Note: During yard operations, the following will apply:

- All yard activities (loading/unloading, soil/aggregate stockpiling) located within the bunded areas;
- Monitoring rain forecast, particularly for events predicted to exceed the 20% AEP (5 year) rainfall event. Inspection of bunds prior to predicted event; and
- Inspection and prompt repair (if required) of bunds following rainfall 20% AEP (5 year).

2.5 Risk Analysis and Contingency Measures

The potential risk of increased sediment discharges from activities of this SCWMP is assessed in Table 2.2, along with specific measures (both structural and/or non-structural) to address this risk.

Table 2.2 – Risk assessment

Risk activity	Specific measures	Residual risk after controls
Untreated sediment laden discharges to stream.	Silt fences between working area and stream, installed prior to any earthworks commencing.	Low
	A “no-go” buffer of 10 m between the stream and working area.	
	Earthwork staging to target periods of suitable weather. This staging shall allow for time to stabilise undertaken works prior to forecasted poor weather.	
Flooding of partially completed works in the flood plain	A suitable weather forecast required to start works.	Low
	Earthwork staging to prioritise completing and stabilising the flood protection bunds.	
	Earthwork staging to target periods of suitable weather. This staging shall allow for time to stabilise undertaken works prior to forecasted poor weather.	
Flooding of completed yard in the flood plain	Refer Section 2.6.	Low

In accordance with the CWMP, this SCWMP includes a risk assessment process to assess works in the winter period (1 May to 30 September inclusive).

As per SCWMP template	
Date prepared	13 July 2018
Is Winter Works required	Yes or No
Next review date	1 April 2019

2.6 Yard Operations

Once the yard is operational, dust and sediment generation shall be managed in accordance with the Dust and Traffic Management Plans. In summary:

- Unsealed surfaces kept damp to reduce dust emissions in areas near sensitive receptors (e.g. by use of water carts).
- Where practical, compact unconsolidated surfaces to minimise dust.
- Compact unconsolidated surfaces over 10 m length at SAP2
- Stabilisation of surfaces when works are completed by grassing, metalling or sealing surfaces to reduce dust emissions.
- Reducing transportation of dust through regular cleaning of vehicles including wheels and limiting vehicle speeds.
- Covering truck loads if the materials carried are fine, dry or otherwise likely to generate dust when travelling off-site.

Yard operations include the use and storage of hazardous materials. Contaminant spills shall be managed in accordance with Section 5.4 of the Construction Environmental Management Plan. In addition, the following will apply:

- Immediately bund off spill area.
- Notify the Construction Supervisor.
- Notify the Environmental Manager immediately of all spills within 10 m of a watercourse (stream or drain).

Due to the underlying soft soils, some earthworks may be required to keep the flood protection bunds at an operational level. If this is required, a separate SCWMP will be prepared to set out these works.

If releveling of the yard pad is required, this will be carried out using low fines material (e.g. AP65). Where low fines material cannot be used, the working area shall be shaped or directed to a DEB (existing or newly constructed), prior to forecasted rainfall.

Appendices

Appendix A: Drawings and calculations	13
Appendix B: Chemical Treatment Bench Tests and Design	14

Appendix A: Drawings and calculations

- Drawings MMA-DES-ESC-E1_DRG-1111 to 1115
- Calculation: DEB-YD
- Calculation: Clean water diversions for Construction Yard

Calculation sheet: DEB for YARD

Required Volume						Assumptions
Pond ID	DEB-YD (STG 1)	DEB-YD (STG 2)	DEB-YD (STG 3)	DEB-YD (STG 3+4)	DEB-YD (Stabilised STG 1-3- if required)	
Catchment area (m2)	2500	3000	1900	3000	7400	Earth catchment = max 0.3 ha . Hardfill catchment = max 1 ha (as per NZTA guidelines for flat gravel)
Slope (%)	<5%	<5%	<5%	<5%	<5%	Existing slope <5%
Runoff coefficient	0.4	0.4	0.4	0.4	0.33	C=0.4; Bare compacted soil smooth, silt loam slope 10-20%. C=0.33 from sloping gravel 90% of area and geotextile lined bunds.
I (20 yr-1hr)	42.6	42.6	42.6	42.6	43.6	from HIRDS for 1hr storm
Storage volume (20 yr - 1 hr storm)	43	51	32	51	106	NZTA method used
Required forebay volume (10% of main) (m3)	NA	NA	NA	NA	NA	Forebay not required
Total storage volume (m3)	43	51	32	51	106	Critical volume: 51 m3
Run off from stabilised catchment	0.325	0.325	0.325	0.325	NA	C=0.33 ; C=0.3 from sloping gravel 95% of area, C=0.8; geotextile lined bunds 5% of area
Ponding depth (mm)	13.8	11.5	18.2	11.5	NA	Estimated ponding from runoff

Available volume		
side slope 1v in	Water Depth (WD)	pond width at WD
2 Pond Width (Top)	0.75 Pond Depth	5.5 pond length at WD
6.5 Side bund top width	1 Pond Length (Top)	20
0.25	21.0	Ratio 1 to 3.6

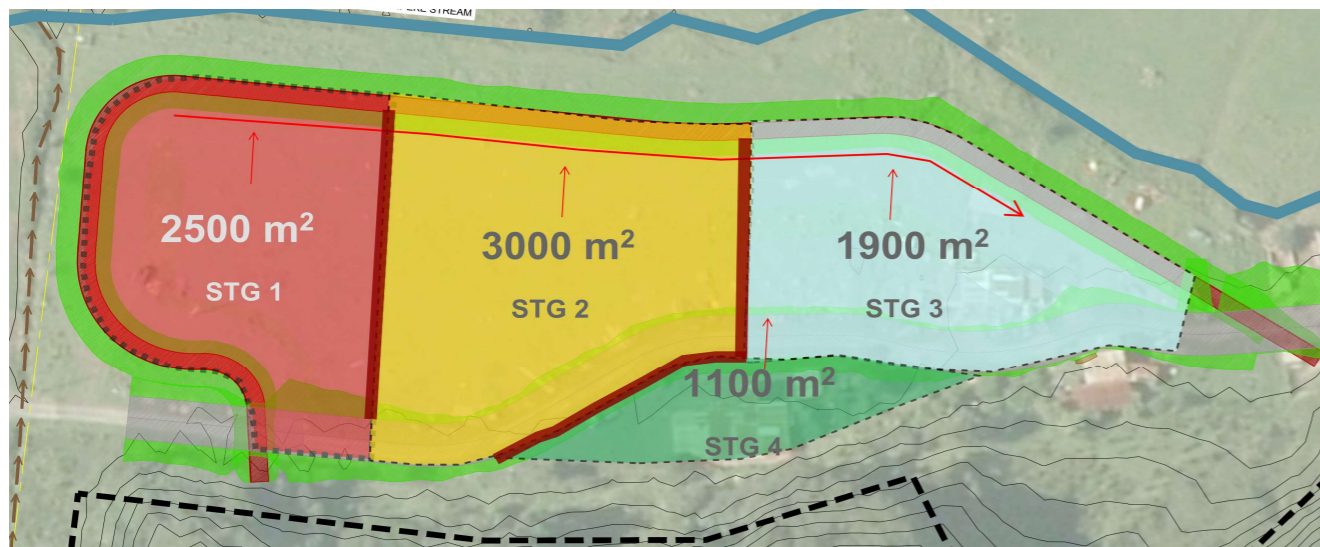

VolB1	82.5	W x H x D	E3 x E5 x D3	w0 = D3 * C3
VolB2	22.5	W x H x D	(C3 x D3) x D3 x E5	
VolB3 (4of)	0.6	0.333 x W x H x D	1/3 x w0 x D3 x w0	
Basin Vol (less internal bunds)	57.8	VolB1 - VolB2 - (VolB3 x 4)		
Check if Available > Required	ok			

Calculation sheet: CWD for ConYard

Table 1: Design flow		Rational method				Comments
	Catchment 1	Catchment 2	Catchment 3	Catchment 4		
Area (ha)	0.06	0.24	0.1	2.1	Silt loam, steep vegetated	
C	0.7	0.7	0.7	0.7	0.7 slope from HIRDs @ Project site for	
i-20	42.6	42.6	42.6	42.6	42.6 5% AEP event	
i-100	60.3	60.3	60.3	60.3	60.3 1% AEP event	
Q -20 m3/s	0.005	0.020	0.008	0.174	Design flow for 5% AEP	
Q -100 m3/s	0.007	0.028	0.012	0.246	Design flow for 1% AEP	

Figure 1: Catchment boundaries

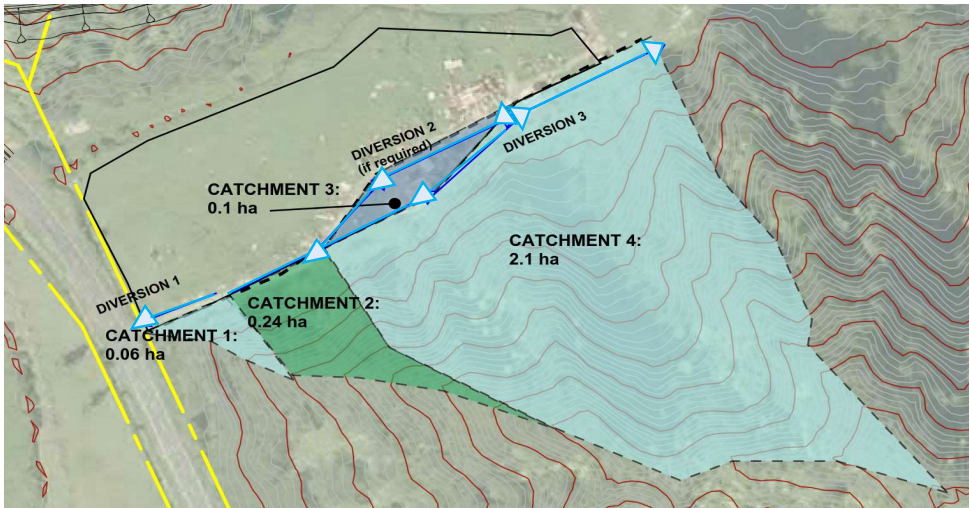
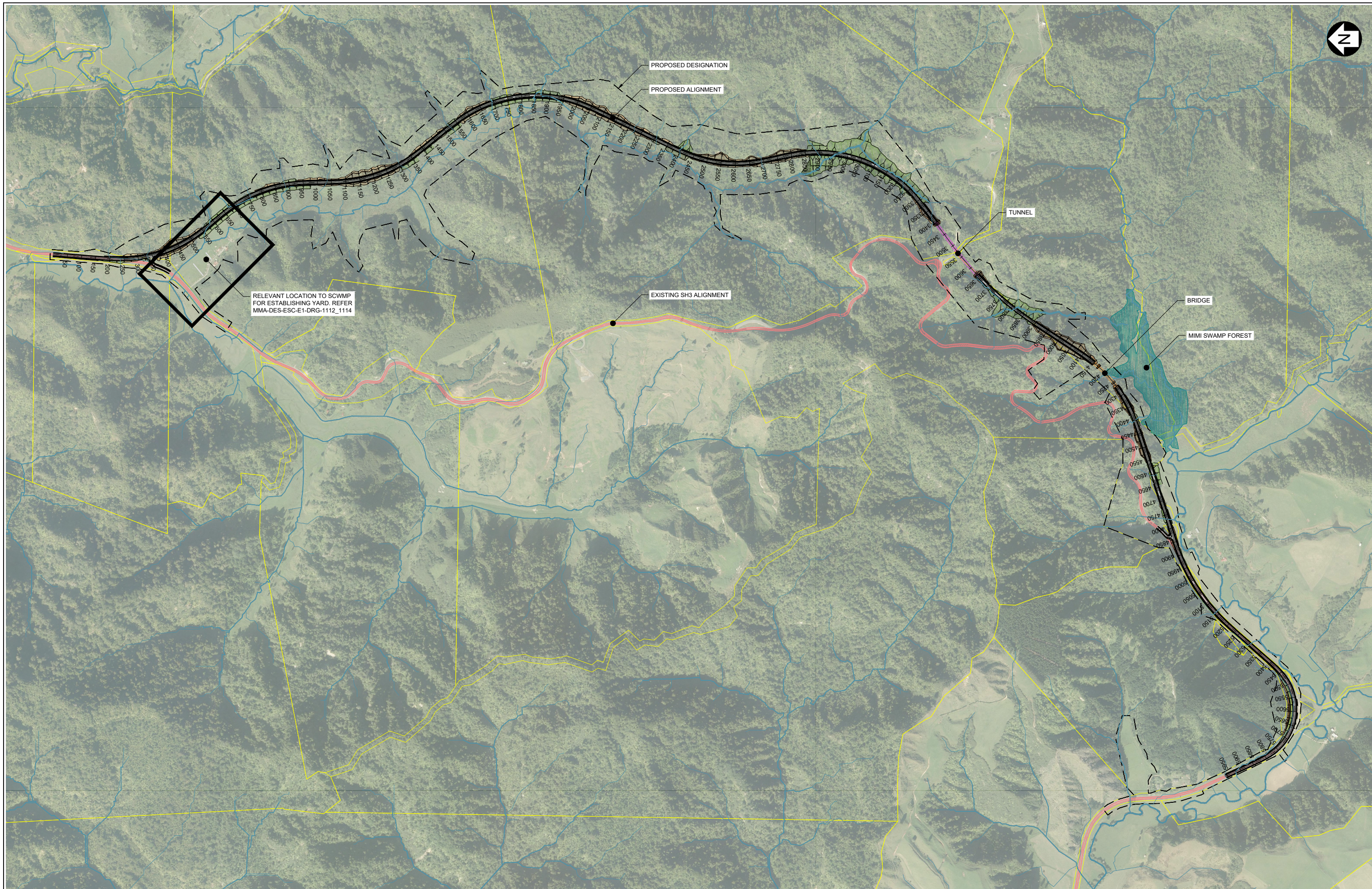
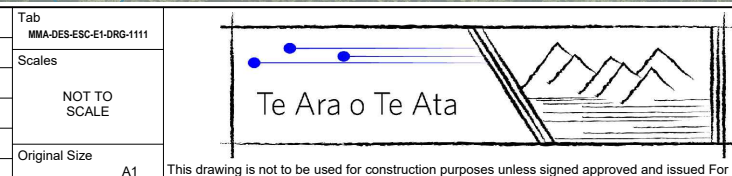

Table 2: Diversion sizing

Channel parameters	Diversion 1	Diversion 2 (if req)	Diversion 3	Comments
Design Catchment	Catchment 1	Catchments 2+ 3 +4	Catchments 2+4	Refer Figure 1
Design flow (m3/s)	0.005	0.20	0.18	Refer Q-20 flows in Table 1
Description	Diversion bund, constructed channel, culvert	Diversion bund, constructed channel	constructed channel	Nominal shape of trapezoidal with 1:2 side slopes assumed for constructed channels. Diversion bund assumed with 1:3 side slope
Grade	2-10%	2-10%	2-10%	Constructed grade
Roughness coefficient n	0.03	0.03	0.03	assumed for geotextile lined channel (0.02-0.03)
Flow depth (m)	0.02-0.03	0.13 -0.19	0.12-0.18	Will vary with rainfall. Design rainfall of 1 in 20 year, 1hr storm assumed
Stabilised depth (m)	0.35	0.5	0.5	Max flow depth + 300 mm freeboard
Base width (m)	0.4	0.5	0.5	Nominal width assumed. Min width of



Tab	MMA-DES-ESC-E1-DRG-1111						
Scales	NOT TO SCALE						
Original Size	A1						
Rev	Revision Description	Drawn	Checked	Designed	Design Checked	Approved	Date
B	STAGING AMENDED, MINOR AMENDMENTS TO DETAILS	QDO'S	GGC*	SPP	SH	LJG	13/07/2018
A	FOR INFORMATION	QDO'S	GGC*	SPP	HM	BSS	24/05/2018



MT MESSENGER BYPASS

EROSION AND SEDIMENT CONTROL SCWMP FOR ESTABLISHING YARD LOCATION PLAN

Approved	NOT FOR CONSTRUCTION
Status	FOR INFORMATION
Drawing Number	MMA-DES-ESC-E1-DRG-1111
Revision	B

NOTES

1. ALL DRAWING REFERENCES SHOWN CAN BE FOUND WITHIN SCWMP FOR ESTABLISHING YARD DRAWING SET (MMA-DES-ESC-E1-DRG-1111_1115).

NOTE

SUPERVISOR RESPONSIBLE TO ENSURE WORKS UNDERTAKEN IN SUITABLE WEATHER WINDOW ONLY

NO ALTERATIONS WITHOUT PRIOR APPROVAL

MEASUREMENTS AND AREAS ARE APPROXIMATE ONLY AND SUBJECT TO SURVEY PRIOR TO CONSTRUCTION

LEGEND

- DESIGNATION BOUNDARY
- YARD (STABILISED)
- EXISTING STREAM
- EXISTING DRAINAGE DITCH
- DEB-YD (SIZED FOR 0.3ha EARTH CATCHMENT & 0.44ha HARDFILL CATCHMENT)
- SILT FENCE
- CLEANWATER DIVERSION (TYPE A)
- CLEANWATER DRAIN (TYPE B)
- DIRTY WATER DRAIN
- ACCESS ROAD
- FLOOD PROTECTION BUNDS
- STABILISED OUTLETS POINTS
- EARTHWORKING AREA (ARROW IS DIRECTION OF SHAPING)
- TOPSOIL BUND (UNLINED)
- TOPSOIL BUND (LINED)

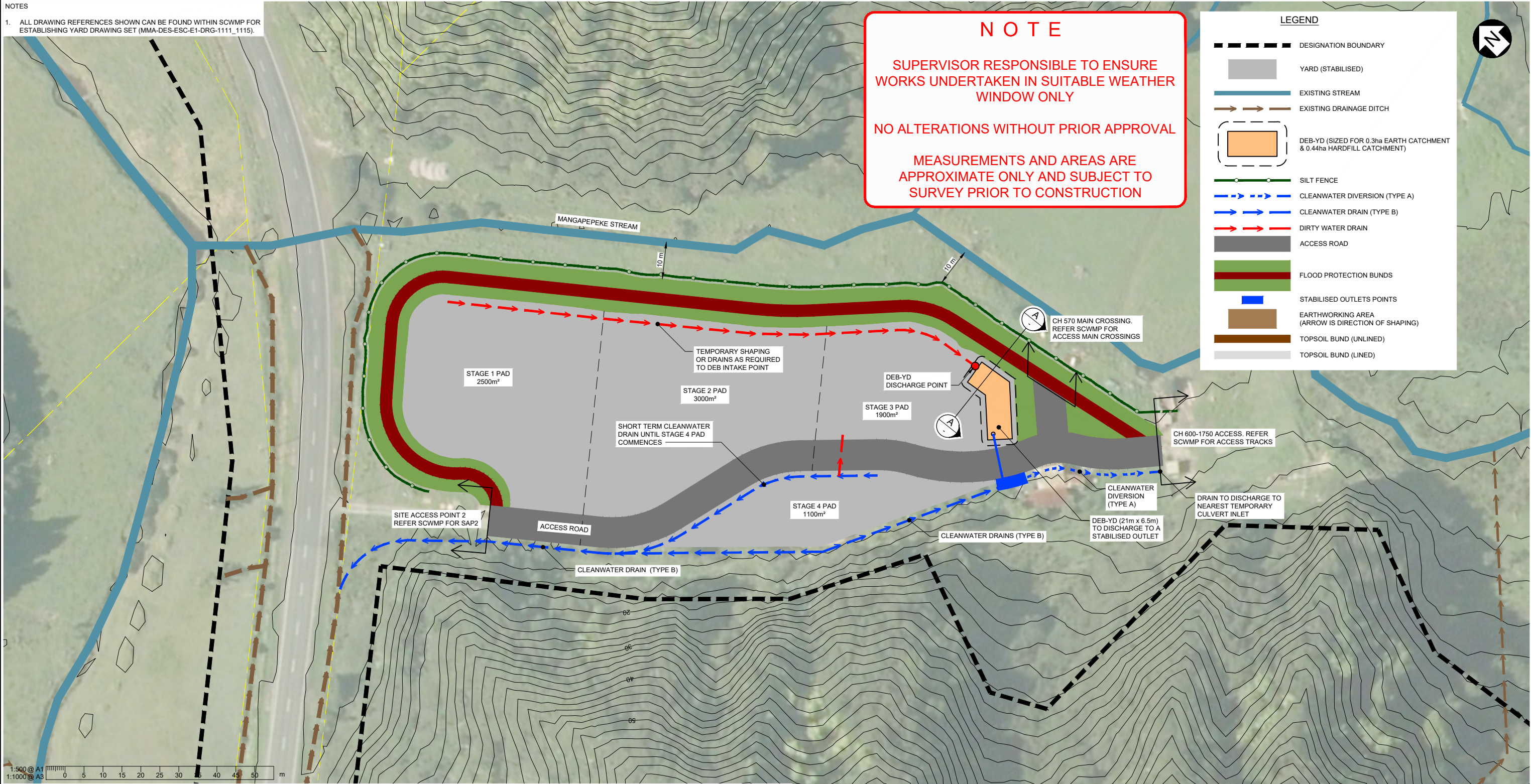

NOTE: EXISTING R.L.'S ARE BASED ON LIDAR SURVEY. R.L.'S TO BE CONFIRMED WITH SPOT SURVEY PRIOR TO CONSTRUCTION.

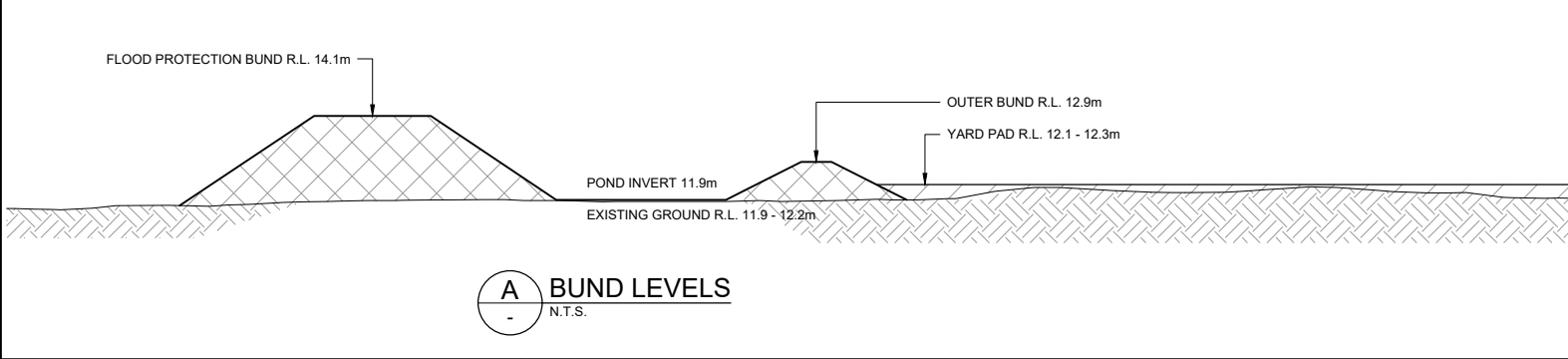

Rev	Revision Description	Drawn	Checked	Designed	Approved	Date	
B	STAGING AMENDED, MINOR AMENDMENTS TO DETAILS	QDO'S	GGC*	SPP	SH	LJG	13/07/2018
A	FOR INFORMATION	QDO'S	GGC*	SPP	HM	BSS	24/05/2018

Tab	MMA-DES-ESC-E1-DRG-1112
Scales	1:1000 (A3) 1:500 (A1)
Original Size	A1

Te Ara o Te Ata

This drawing is not to be used for construction purposes unless signed approved and issued For Construction

NZ TRANSPORT AGENCY
WAKA KOTAHĪ

Mt Messenger Bypass

MT MESSENGER BYPASS

EROSION AND SEDIMENT CONTROL SCWMP FOR ESTABLISHING YARD LAYOUT PLAN

Approved	NOT FOR CONSTRUCTION
Status	FOR INFORMATION
Drawing Number	MMA-DES-ESC-E1-DRG-1112
Revision	B

STEP 1 (TASKS A-C): A) SET OUT STREAM BUFFER ZONE. SET OUT TOE OF FLOOD PROTECTION BUNDS SO IT DOESN'T ENCROACH INTO THE BUFFER ZONE. INSTALL SILT FENCE AT TOE.
B) BLOCKING OFF EXISTING FARM DRAINS AND CULVERTS. INSTALL CLEAN WATER DRAINS TO DIVERT THE UPSLOPE CATCHMENT.
C) CONSTRUCT DEB-YD.
STEP 2 (A): STAGED EARTHWORKS TO CONSTRUCT AND STABILISE BUNDS, ACCESS ROAD AND YARD. STRIPPED TOPSOIL WILL BE PUSHED INTO A TEMPORARY TOPSOIL BUND.
FLOOD PROTECTION BUND: NO MORE THAN 50m LENGTH OF UNLINED BATTER FACE AT THE END OF EACH WORKING DAY.

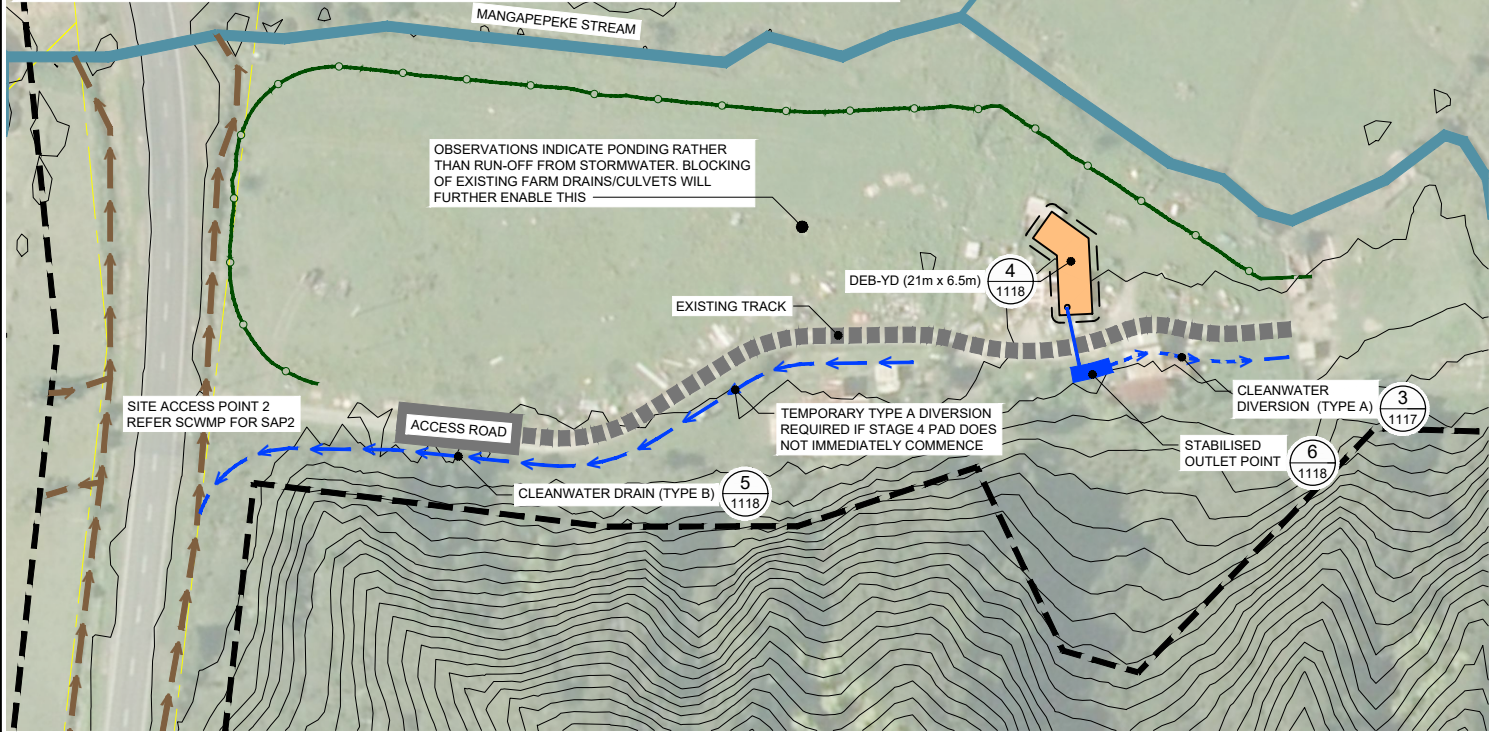

STEP 2 (A): STAGED EARTHWORKS TO CONSTRUCT AND STABILISE BUNDS, ACCESS ROAD AND YARD. STRIPPED TOPSOIL WILL BE PUSHED INTO A TEMPORARY TOPSOIL BUND.
FLOOD PROTECTION BUND: NO MORE THAN 50m LENGTH OF UNLINED BATTER FACE AT THE END OF EACH WORKING DAY.
DIRTY WATER CUT-OFF: DIRTY WATER CUT-OFF DRAIN REINSTATED AT THE END OF EACH DAY, AND PRIOR TO FORECASTED RAIN.

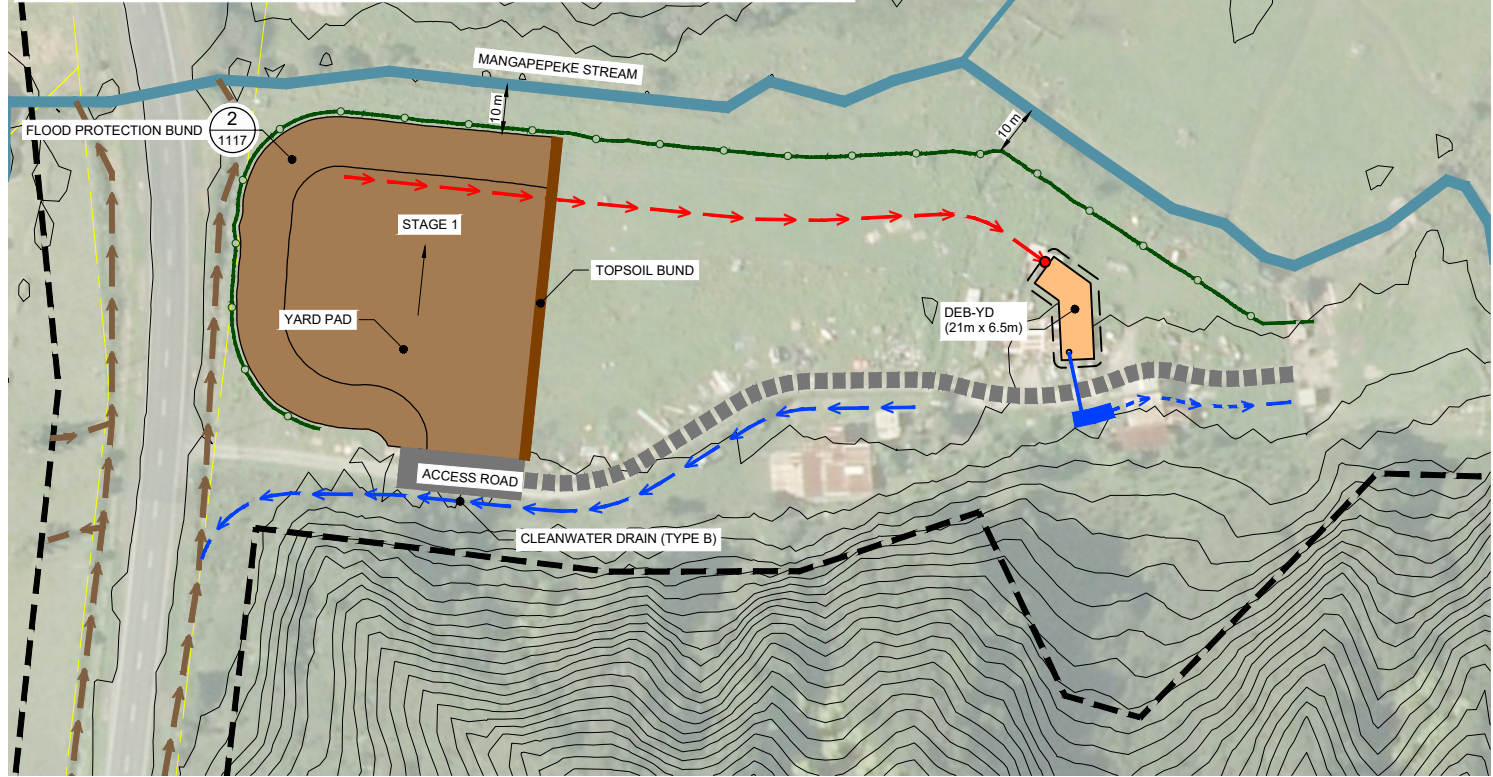

STEP 2 (B): STAGE 1 PAD HAS BEEN STABILISED WITH HARDFILL. A GEOTEXTILE LINED TOPSOIL BUND SEPARATES STAGE 1 AND 2 AREAS.
STAGED EARTHWORKS TO CONSTRUCT AND STABILISE BUNDS, ACCESS ROAD AND YARD. STRIPPED TOPSOIL WILL BE PUSHED INTO A TEMPORARY TOPSOIL BUND.
FLOOD PROTECTION BUND: NO MORE THAN 50m LENGTH OF UNLINED BATTER FACE AT THE END OF EACH WORKING DAY. DIRTY WATER CUT-OFF: DIRTY WATER CUT-OFF DRAIN REINSTATED AT THE END OF EACH DAY, AND PRIOR TO FORECASTED RAIN.

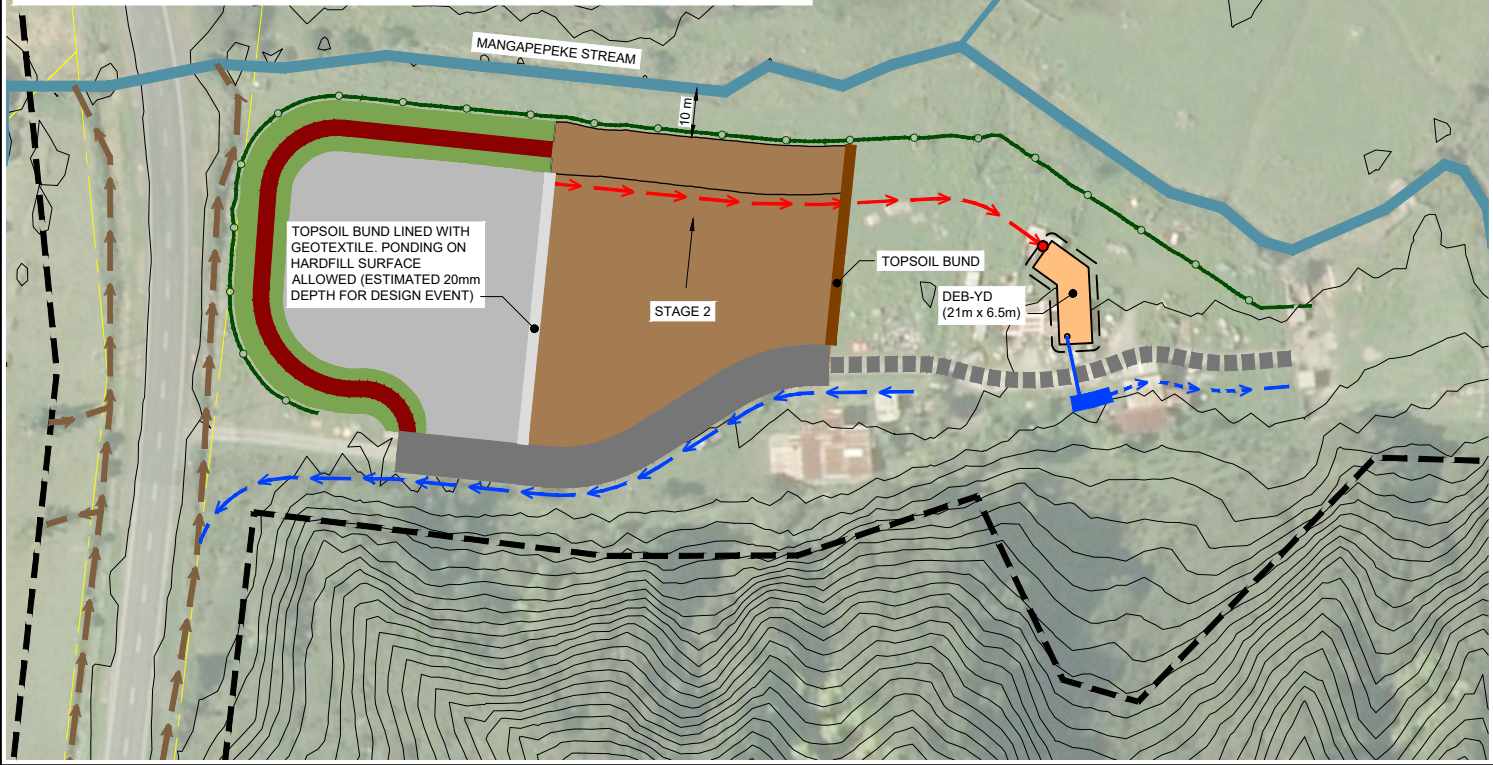

LEGEND

- DESIGNATION BOUNDARY
- YARD (STABILISED)
- EXISTING STREAM
- EXISTING DRAINAGE DITCH
- DEB-YD (SIZED FOR 0.3ha EARTH CATCHMENT & 0.44ha HARDFILL CATCHMENT)
- SILT FENCE
- CLEANWATER DIVERSION (TYPE A)
- CLEANWATER DRAIN (TYPE B)
- DIRTY WATER DRAIN
- ACCESS ROAD
- FLOOD PROTECTION BUNDS
- STABILISED OUTLETS POINTS
- EARTHWORKING AREA (ARROW IS DIRECTION OF SHAPING)
- TOPSOIL BUND (UNLINED)
- TOPSOIL BUND (LINED)

NOTE

SUPERVISOR RESPONSIBLE TO ENSURE WORKS UNDERTAKEN IN SUITABLE WEATHER WINDOW ONLY

NO ALTERATIONS WITHOUT PRIOR APPROVAL

MEASUREMENTS AND AREAS ARE APPROXIMATE ONLY AND SUBJECT TO SURVEY PRIOR TO CONSTRUCTION

Rev	Revision Description	Drawn	Checked	Designed	Design Checked	Approved	Date
B	STAGING AMENDED, MINOR AMENDMENTS TO DETAILS	QDO'S	GGC*	SPP	SH	LJG	13/07/2018
A	FOR INFORMATION	QDO'S	GGC*	SPP	HM	BSS	24/05/2018

Tab	MMA-DES-ESC-E1-DRG-1113
Scales	NOT TO SCALE
Original Size	A1

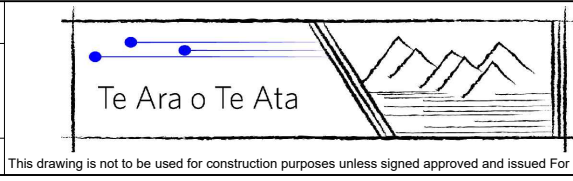

MT MESSENGER BYPASS

**EROSION AND SEDIMENT CONTROL
SCWMP FOR ESTABLISHING YARD
STAGING - SHEET 1**

Approved	NOT FOR CONSTRUCTION
Status	FOR INFORMATION
Drawing Number	MMA-DES-ESC-E1-DRG-1113
Revision	B

STEP 2 (C): STAGE 2 PAD HAS BEEN STABILISED WITH HARDFILL. A GEOTEXTILE LINED TOPSOIL BUND SEPARATES STAGE 2 AND 3 AREAS. STAGED EARTHWORKS CONTINUE TO CONSTRUCT AND STABILISE BUNDS, ACCESS ROAD AND YARD. STRIPPED TOPSOIL WILL BE PUSHED INTO A TEMPORARY TOPSOIL BUND. **FLOOD PROTECTION BUND:** NO MORE THAN 50m LENGTH OF UNLINED BATTER FACE AT THE END OF EACH WORKING DAY. **DIRTY WATER CUT-OFF:** DIRTY WATER CUT-OFF DRAIN REINSTATED AT THE END OF EACH DAY, AND PRIOR TO FORECASTED RAIN.

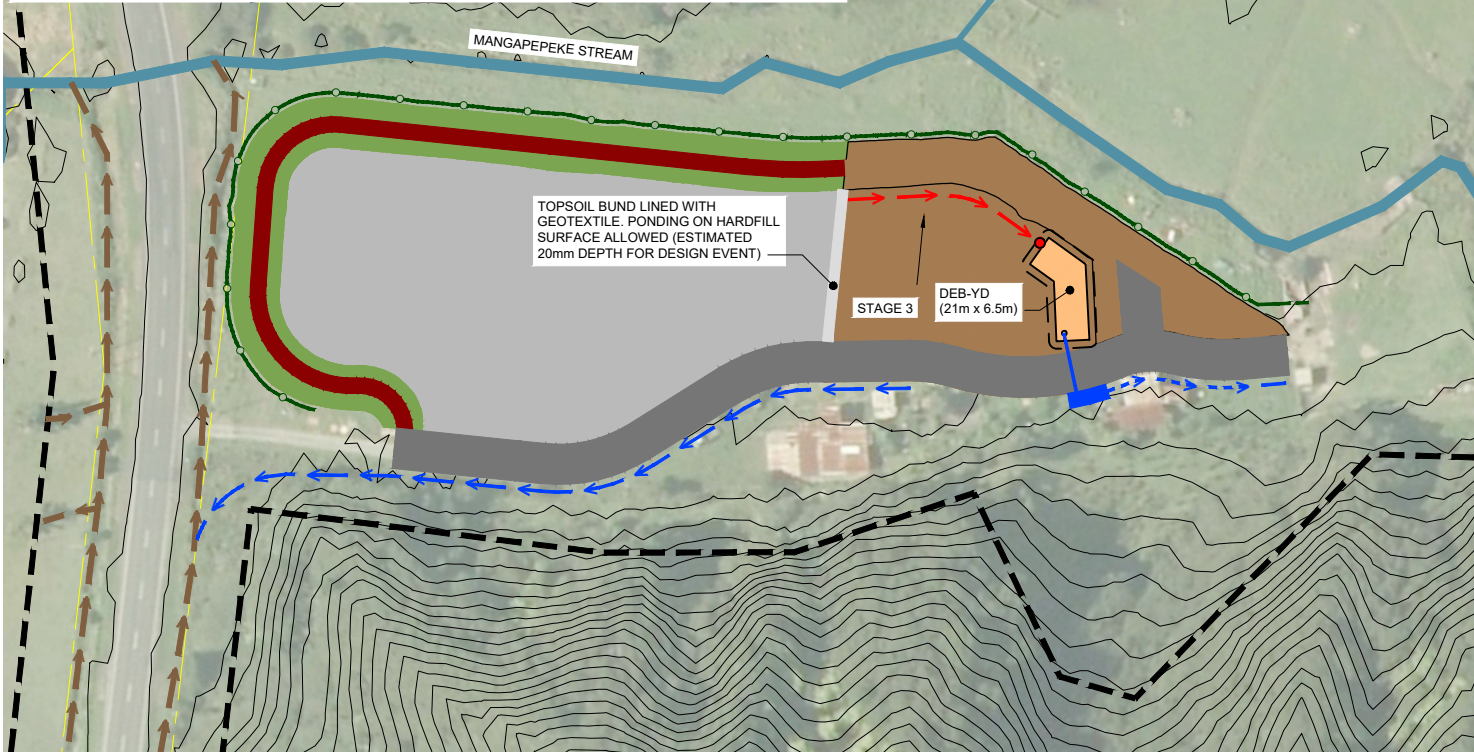

STEP 3: REMOVE EXISTING DWELLING ONCE PERMISSION IS OBTAINED. REALIGN CLEANWATER DRAIN. COMPLETE FINAL STAGE OF EARTHWORKS TO EXTEND THE YARD. STRIPPED TOPSOIL WILL BE PUSHED INTO A TEMPORARY BUND. LOCALISED TRENCHING TO INSTALL SERVICES. SERVICE TRENCHES PROGRESSIVELY BACKFILLED.

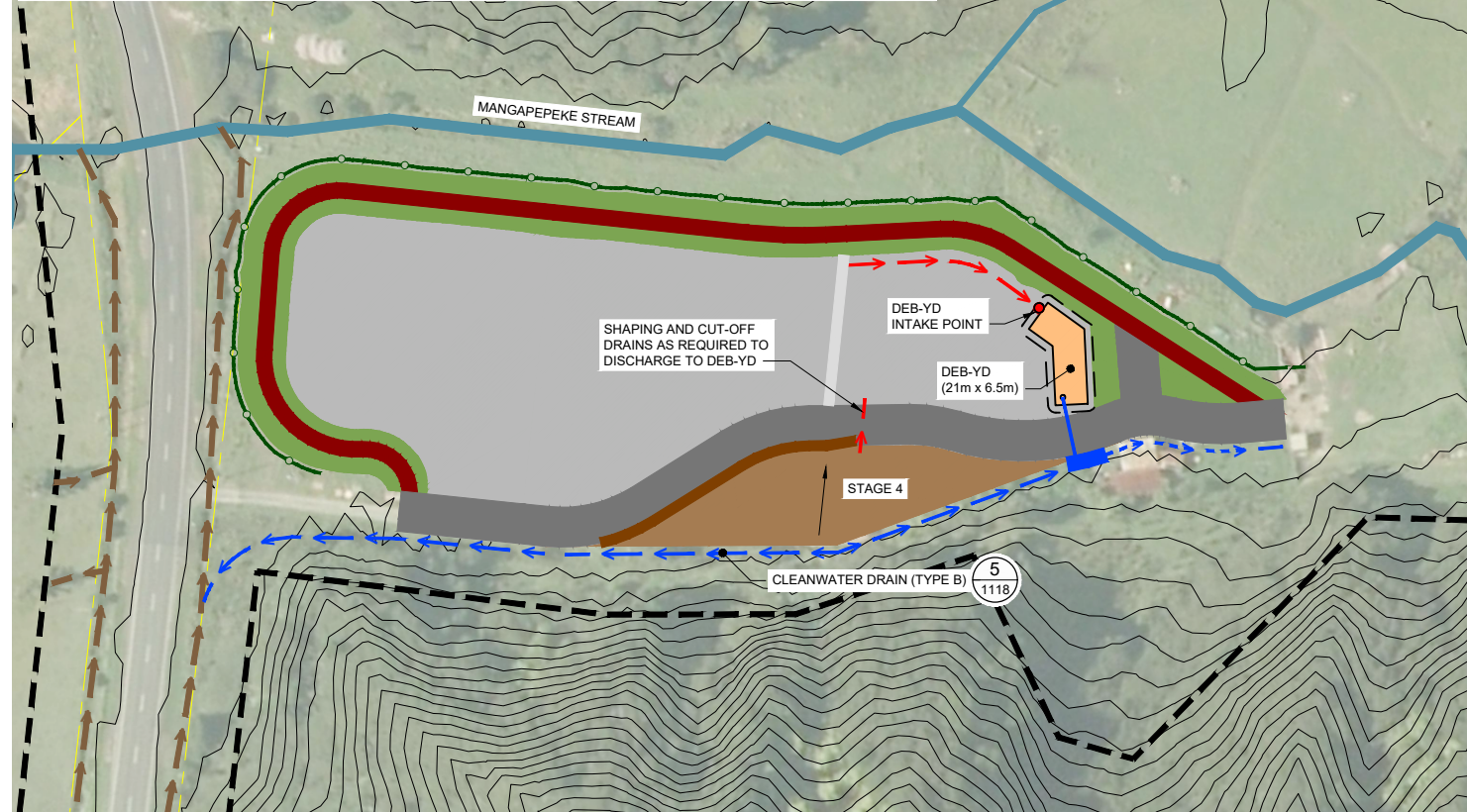

LEGEND

- DESIGNATION BOUNDARY
- YARD (STABILISED)
- EXISTING STREAM
- EXISTING DRAINAGE DITCH
- DEB-YD (SIZED FOR 0.3ha EARTH CATCHMENT & 0.44ha HARDFILL CATCHMENT)
- SILT FENCE
- CLEANWATER DIVERSION (TYPE A)
- CLEANWATER DRAIN (TYPE B)
- DIRTY WATER DRAIN
- ACCESS ROAD
- FLOOD PROTECTION BUNDS
- STABILISED OUTLETS POINTS
- EARTHWORKING AREA (ARROW IS DIRECTION OF SHAPING)
- TOPSOIL BUND (UNLINED)
- TOPSOIL BUND (LINED)

NOTE

SUPERVISOR RESPONSIBLE TO ENSURE WORKS UNDERTAKEN IN SUITABLE WEATHER WINDOW ONLY

NO ALTERATIONS WITHOUT PRIOR APPROVAL

MEASUREMENTS AND AREAS ARE APPROXIMATE ONLY AND SUBJECT TO SURVEY PRIOR TO CONSTRUCTION

Rev	Revision Description	Drawn	Checked	Designed	Design Checked	Approved	Date
B	STAGING AMENDED, MINOR AMENDMENTS TO DETAILS	QDO'S	GGC*	SPP	SH	LJG	13/07/2018
A	FOR INFORMATION	QDO'S	GGC*	SPP	HM	BSS	24/05/2018

Tab	MMA-DES-ESC-E1-DRG-1114
Scales	NOT TO SCALE
Original Size	A1

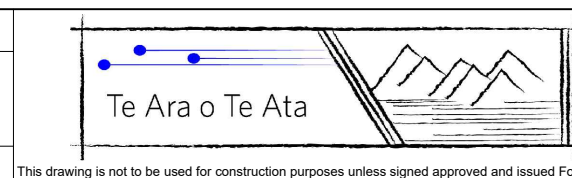

MT MESSENGER BYPASS
EROSION AND SEDIMENT CONTROL
SCWMP FOR ESTABLISHING YARD
STAGING - SHEET 2

Approved	NOT FOR CONSTRUCTION
Status	FOR INFORMATION
Drawing Number	MMA-DES-ESC-E1-DRG-1114
Revision	B

NOTES
 1. ALL LEVELS TO BE CONFIRMED BY SURVEY PRIOR TO CONSTRUCTION.

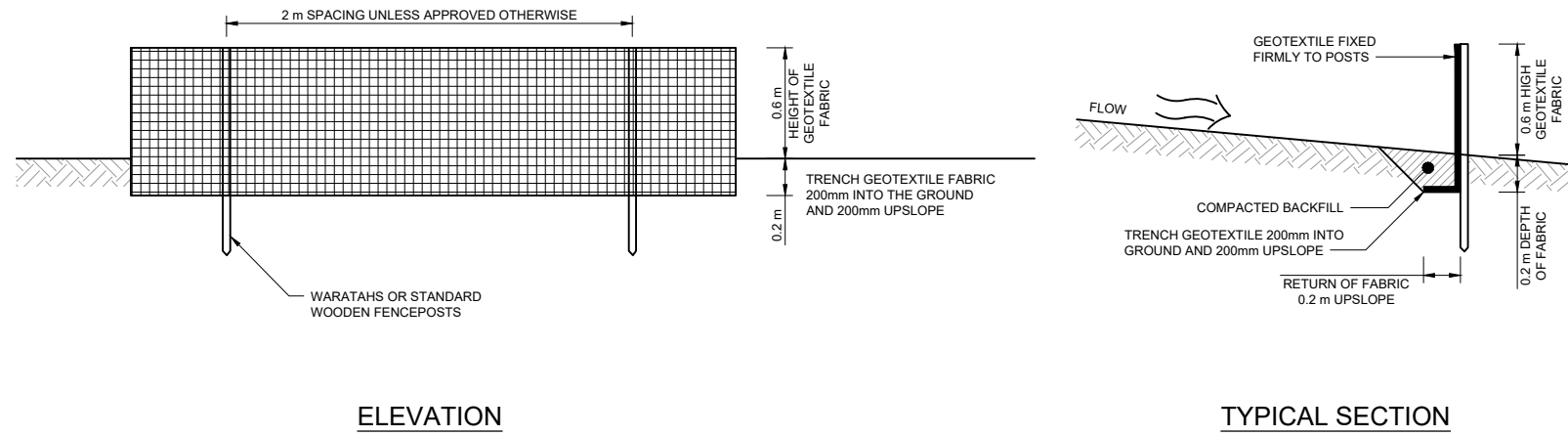

1 SILT FENCE
 N.T.S.

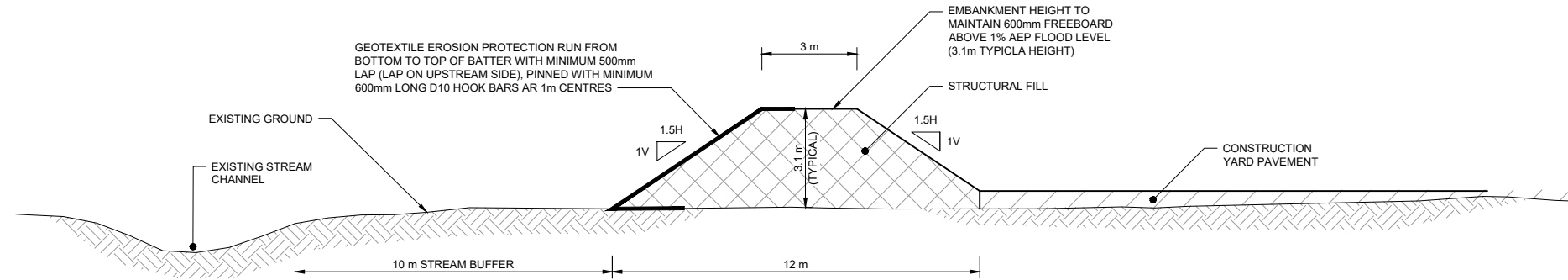

2 FLOOD PROTECTION BUND TYPICAL CROSS SECTION
 1113 N.T.S.

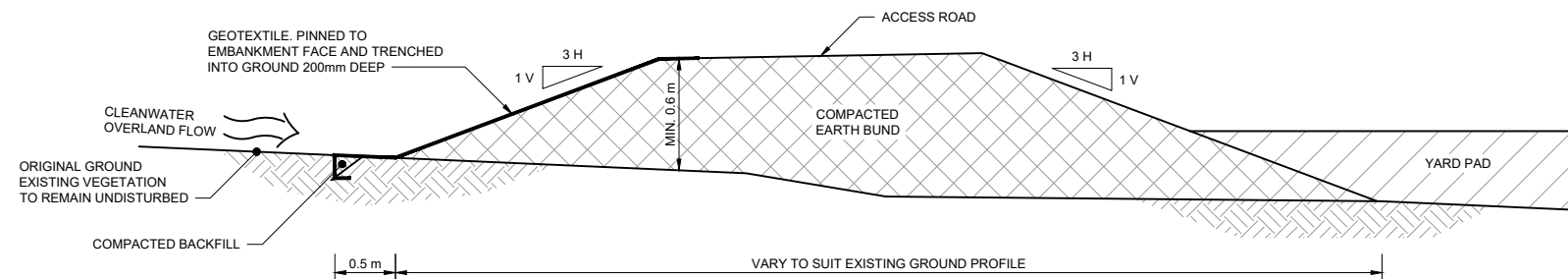

3 CLEANWATER DIVERSION (TYPE A) CONSTRUCTED GRADE OF 2-10%
 1113 N.T.S.

Rev	Revision Description	Drawn	Checked	Designed	Design Checked	Approved	Date
B	STAGING AMENDED, MINOR AMENDMENTS TO DETAILS	QDO'S	GGC*	SPP	SH	LJG	13/07/2018
A	FOR INFORMATION	QDO'S	GGC*	SPP	GR	BSS	24/05/2018

Tab	MMA-DES-ESC-E1-DRG-1117
Scales	NOT TO SCALE
Original Size	A1

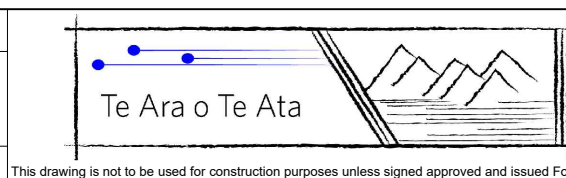

MT MESSENGER BYPASS
 EROSION AND SEDIMENT CONTROL
 SCWMP FOR ESTABLISHING YARD
 DETAILS SHEET 1

Approved	NOT FOR CONSTRUCTION
Status	FOR INFORMATION
Drawing Number	MMA-DES-ESC-E1-DRG-1117
Revision	B

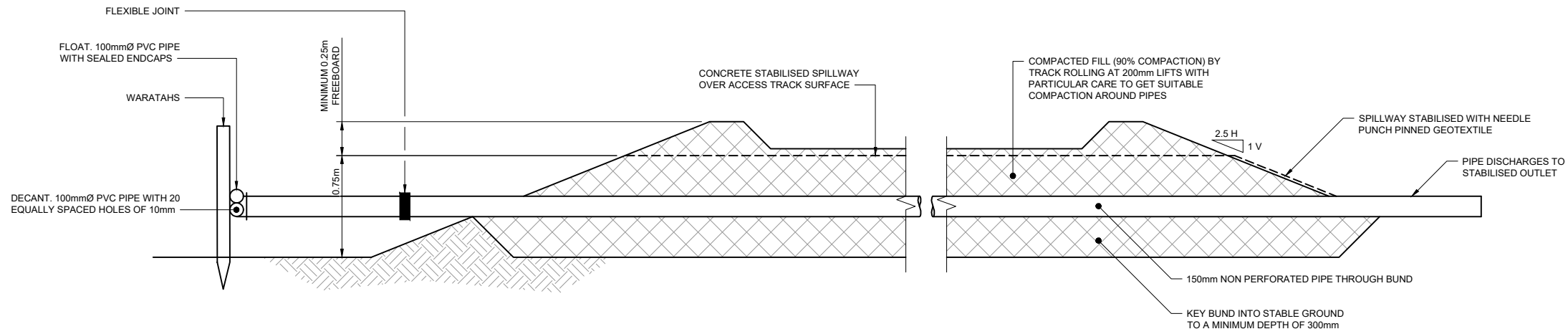

B DECANTING OUTLET
N.T.S.

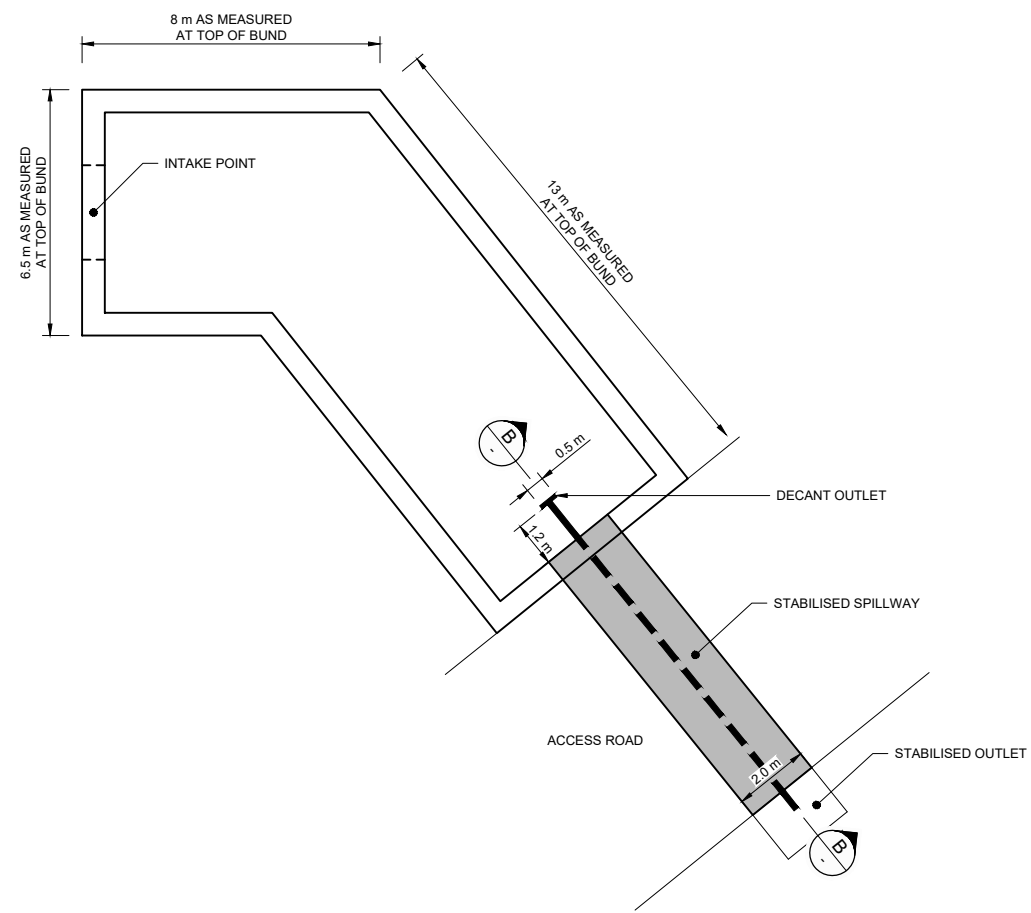

4 DECANTING EARTH BUND
1113 N.T.S.

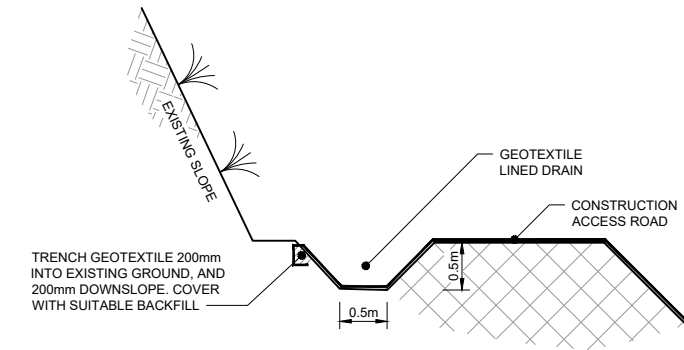

5 CLEAN WATER DRAIN (TYPE B) CONSTRUCTED GRADE OF 2-10%
1113 N.T.S.

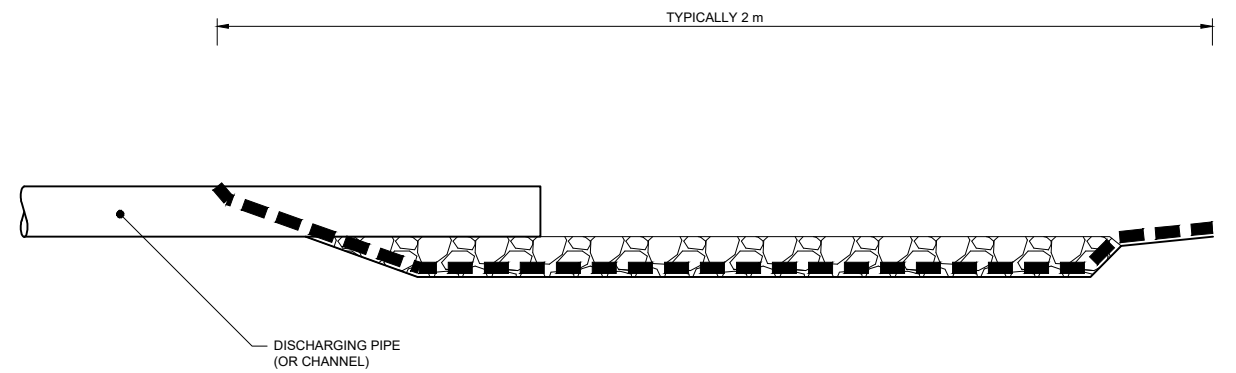

6 STABILISED OUTLET
1113 N.T.S.

Rev	Revision Description	Drawn	Checked	Designed	Design Checked	Approved	Date
B	STAGING AMENDED, MINOR AMENDMENTS TO DETAILS	QDO'S	GGC*	SPP	SH	LJG	13/07/2018
A	FOR INFORMATION	QDO'S	GGC*	SPP	GR	BSS	24/05/2018

Tab	MMA-DES-ESC-E1-DRG-1118
Scales	NOT TO SCALE
Original Size	A1

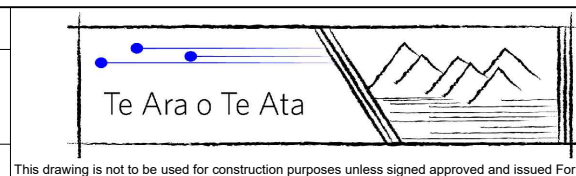

MT MESSENGER BYPASS
EROSION AND SEDIMENT CONTROL
SCWMP FOR ESTABLISHING YARD
DETAILS SHEET 2

Approved	NOT FOR CONSTRUCTION
Status	FOR INFORMATION
Drawing Number	MMA-DES-ESC-E1-DRG-1118
Revision	B

Calculation sheet: DEB for YARD

Required Volume						Assumptions
Pond ID	DEB-YD (STG 1)	DEB-YD (STG 2)	DEB-YD (STG 3)	DEB-YD (STG 3+4)	DEB-YD (Stabilised STG 1-3- if required)	
Catchment area (m2)	2500	3000	1900	3000	7400	Earth catchment = max 0.3 ha . Hardfill catchment = max 1 ha (as per NZTA guidelines for flat gravel)
Slope (%)	<5%	<5%	<5%	<5%	<5%	Existing slope <5%
Runoff coefficient	0.4	0.4	0.4	0.4	0.33	C=0.4; Bare compacted soil smooth, silt loam slope 10-20%. C=0.33 from sloping gravel 90% of area and geotextile lined bunds.
I (20 yr-1hr)	42.6	42.6	42.6	42.6	43.6	from HIRDS for 1hr storm
Storage volume (20 yr - 1 hr storm)	43	51	32	51	106	NZTA method used
Required forebay volume (10% of main) (m3)	NA	NA	NA	NA	NA	Forebay not required
Total storage volume (m3)	43	51	32	51	106	Critical volume: 51 m3
Run off from stabilised catchment	0.325	0.325	0.325	0.325	NA	C=0.33 ; C=0.3 from sloping gravel 95% of area, C=0.8; geotextile lined bunds 5% of area
Ponding depth (mm)	13.8	11.5	18.2	11.5	NA	Estimated ponding from runoff

Available volume		
side slope 1v in	Water Depth (WD)	pond width at WD
2 Pond Width (Top)	0.75 Pond Depth	5.5 pond length at WD
6.5 Side bund top width	1 Pond Length (Top)	20
0.25	21.0	Ratio 1 to 3.6

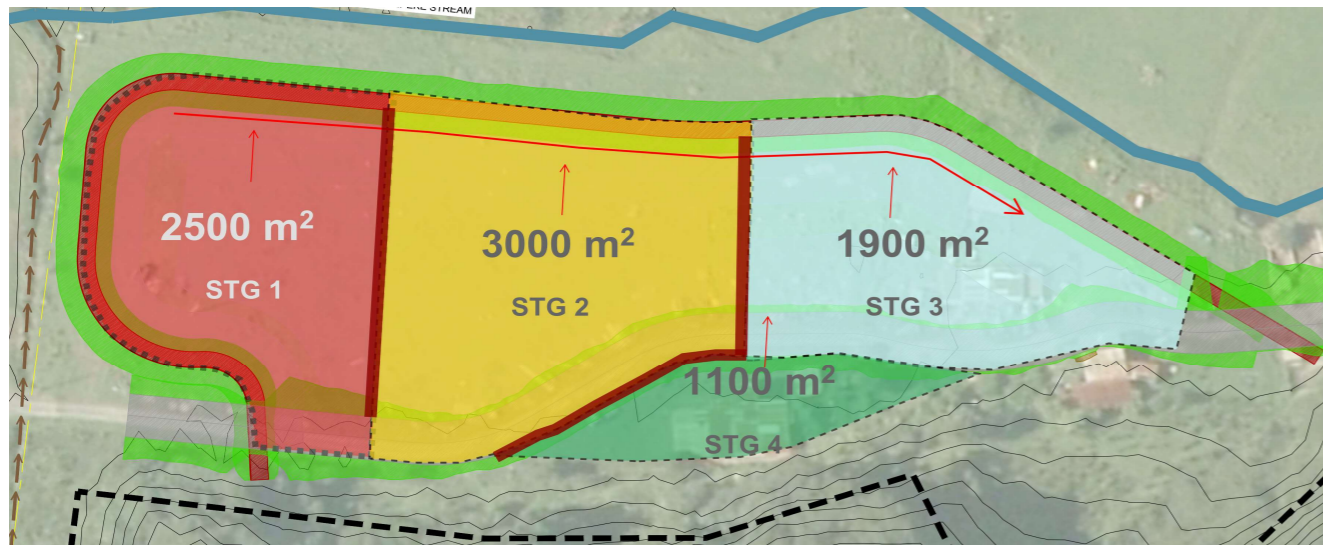

VolB1	82.5	W x H x D	E3 x E5 x D3	w0 = D3 * C3
VolB2	22.5	W x H x D	(C3 x D3) x D3 x E5	
VolB3 (4of)	0.6	0.333 x W x H x D	1/3 x w0 x D3 x w0	
Basin Vol (less internal bunds)	57.8	VolB1 - VolB2 - (VolB3 x 4)		
Check if Available > Required	ok			

Calculation sheet: CWD for ConYard

Table 1: Design flow		Rational method				Comments
	Catchment 1	Catchment 2	Catchment 3	Catchment 4		
Area (ha)	0.06	0.24	0.1	2.1	Silt loam, steep vegetated	
C	0.7	0.7	0.7	0.7	0.7 slope from HIRDs @ Project site for	
i-20	42.6	42.6	42.6	42.6	42.6 5% AEP event	
i-100	60.3	60.3	60.3	60.3	60.3 1% AEP event	
Q -20 m3/s	0.005	0.020	0.008	0.174	Design flow for 5% AEP	
Q -100 m3/s	0.007	0.028	0.012	0.246	Design flow for 1% AEP	

Figure 1: Catchment boundaries

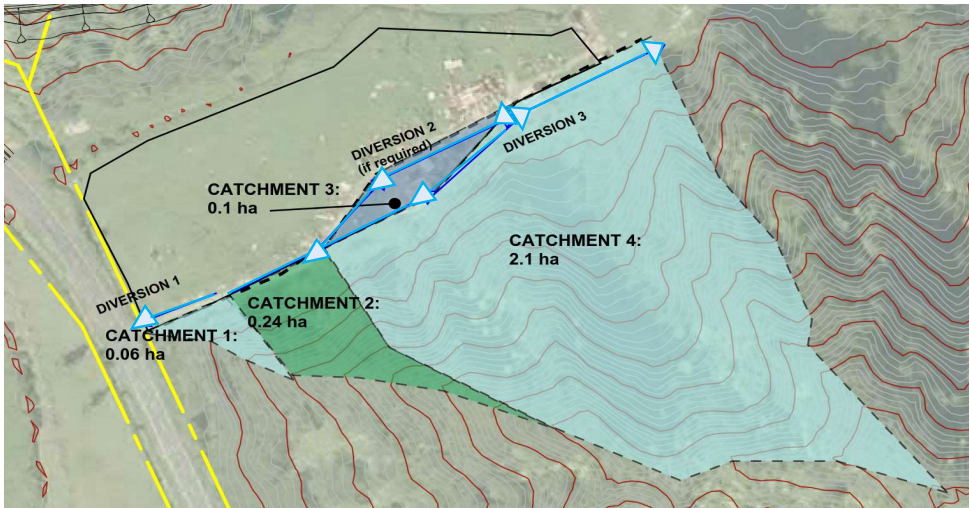

Table 2: Diversion sizing

Channel parameters	Diversion 1	Diversion 2 (if req)	Diversion 3	Comments
Design Catchment	Catchment 1	Catchments 2+ 3 +4	Catchments 2+4	Refer Figure 1
Design flow (m3/s)	0.005	0.20	0.18	Refer Q-20 flows in Table 1
Description	Diversion bund, constructed channel, culvert	Diversion bund, constructed channel	constructed channel	Nominal shape of trapezoidal with 1:2 side slopes assumed for constructed channels. Diversion bund assumed with 1:3 side slope
Grade	2-10%	2-10%	2-10%	Constructed grade
Roughness coefficient n	0.03	0.03	0.03	assumed for geotextile lined channel (0.02-0.03)
Flow depth (m)	0.02-0.03	0.13 -0.19	0.12-0.18	Will vary with rainfall. Design rainfall of 1 in 20 year, 1hr storm assumed
Stabilised depth (m)	0.35	0.5	0.5	Max flow depth + 300 mm freeboard
Base width (m)	0.4	0.5	0.5	Nominal width assumed. Min width of

Appendix B: Chemical Treatment Bench Tests and Design

Mount Messenger, Taranaki

Chemical Management of Soils Using PAC

Northern Construction Yard
22 May 2018

Prepared for

MtMA

22 May 2018

Prepared by

Ridley Dunphy Environmental Limited
PO Box 100
Waitakere
Auckland 0660

Table of Contents

1.0	Soil Sample.....	1
2.0	Results of Bench Tests	1
3.0	Discussion.....	2
4.0	Batch Dosing	3
5.0	Rainfall Activated Dosing Calculations.....	3

1.0 Soil Sample

The soil sample was taken from a blend sample mix of sandstone and mudstone that is considered representative of what will be used for filling in the yard location prior to backfilling and stabilisation with hard fill.



Plate One – Soil Sample

2.0 Results of Bench Tests

Soil Sample

Aluminium Dose. (mg/L)	Final result Coag + settle after 30 min	Clarity (cm) after 30 min	Final pH after 30 min
0	Slightly Cloudy	6.0	5.86
2	Clear	8.0	5.76
4	Very Clear	10.0	5.75
6	Very Clear	10.0	5.71
8	Very Clear	10.0	4.70

3.0 Discussion

The bench tests confirm the applicability of PAC as a flocculant in this SCWMP. The samples showed good results and after 30min there was a clear result for the 4mg/l dose rate. There was significant natural settling in all sample jars confirming the sandy nature of the soil blend bench tested.

pH as a result of the dose changed only very slightly and at a dose rate of 4mg/l of aluminum was 5.75.

The recommended dose for the site is therefore 4 milligrams of aluminium per litre of stormwater volume.



Plate Two - Sample Jars Showing Settlement after immediate mixing for Soil Sample



Plate Three - Sample Jars Showing Settlement after 30 minutes for Soil Sample

4.0 Batch Dosing

Any batch dosing will be based on the following table.

Volume of Stormwater in Detention Device (m ³)	Dosage rate of PAC (litres)
20	1.25
40	2.50
60	3.74
80	5.00
100	6.23
200	12.50
300	18.70

Table One – Batch Dosing PAC Volumes

5.0 Rainfall Activated Dosing Calculations

Rainwater catchment tray calculations and header tank volumes as follows:

Construction Yard DEB based on 0.3ha Contributing Catchment		
Catchment Tray Size (m ²)	Header Tank Low Flow Volume (litres)	Header Tank High Flow Volume (litres)
0.23	2.7	5.4